



MARTIN YALE
Industries

Model 1501

AutoFolder Instructions

Specifications

Functional

Paper Weight.....	16# to 28# Bond Stock (60g-105g)
Form Width.....	3½" min. to 8¾" max.
Form Length.....	5" min. to 14" max.
Feed Table Capacity.....	167 sheets of 20# (1/2" stack)
Speed.....	7500 sheets per hour (8½" X 11")
Fold Styles.....	Letter, Half/Single, Double Parallel, Z, and Brochure
Duty Cycle.....	20,000 sheets per month
Stapled Documents.....	Three 24 # sheets max, hand fed

Physical

Dimensions.....	15½"W X 24"L X 11½"H
Machine Weight.....	31 lbs.
Shipping Weight.....	36 lbs.

Electrical

Power.....	115 V.A.C., 1.3 Amp, Thermal Overload Protected
------------	---

Introduction

Thank you for selecting the Martin Yale Model 1501 Autofolder. We recommend that you familiarize yourself with the 1501 Autofolder by carefully reading these instructions. Thorough understanding of the information contained within this instruction manual will help to eliminate most operator-associated errors and ensure years of trouble-free performance.

WARNING! Never connect power to the machine until you are ready to set up and operate the folder. During set up, operation, and maintenance keep hands, hair, loose clothing, and jewelry away from all moving parts. Serious bodily injury could result. Service, or disassembly of folder should only be attempted with the power disconnected and locked out.

1.0 Parts

1. Feed Table (W-O001669)
2. First Exit Tray (W-O001611)
3. Red Retarder (WRA003116)
4. ON/OFF/MOMENTARY Switch (M-S033064)
5. Antistatic Tinsel (W-A001684)
6. First Fold Table (W-A001602)
7. Upper Paper Guide (W-A001678)
8. Second Exit Tray (W-O001668)
9. Second Fold Table (W-A001604)



Figure #2 Exit View

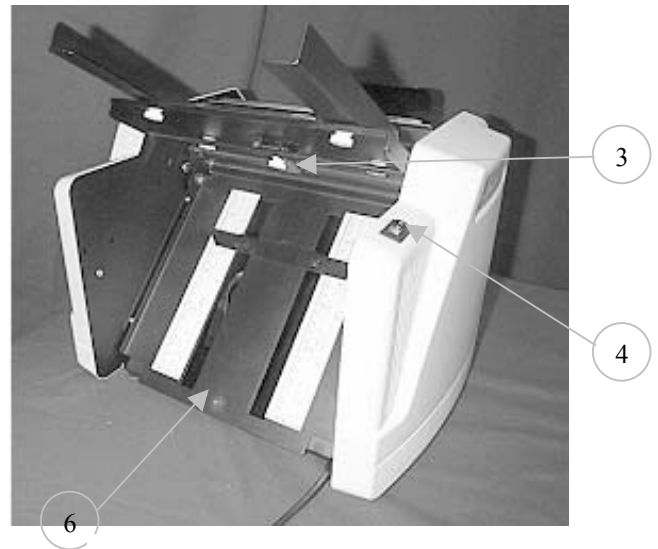

Figure #1 Entry View

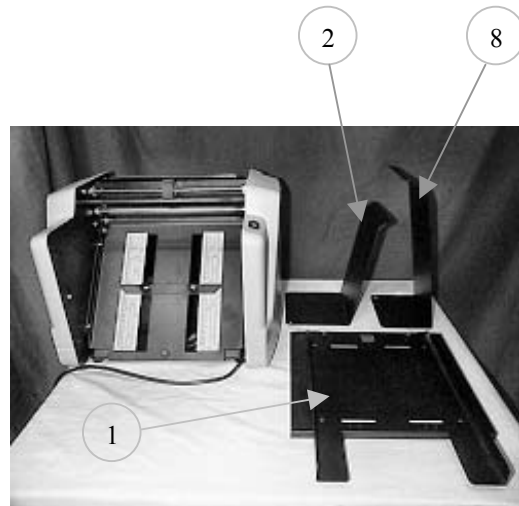

Figure #3 Folder Unpacked

2.0 Installation

2.1 Unpacking

Carefully unpack the 1501 letter folder and accessories. Place the 1501 on a flat, level surface where it will be used. It is necessary to have a clear area behind the folder to place the exit trays. Place all of the packing material back in the shipping box and store the box for any future shipment of the 1501. Inspect the 1501 and all accessories for shipping damage. If any damage is found, contact the carrier immediately. **Note: Never handle the feed table by the paper guides.**

2.2 Feed table assembly

The feed table can be installed in the 1501 by following three simple steps.

First-Locate the Feed Table support pins and support bar (see figure #4).

Second-Place front edge of feed table between side frames at the top of the machine (see figure #5). Push feed table into folder so that the cutout areas on the bottom of the feed table fit onto the feed table support

Feed table support pin and support bar; feed table mounts on these

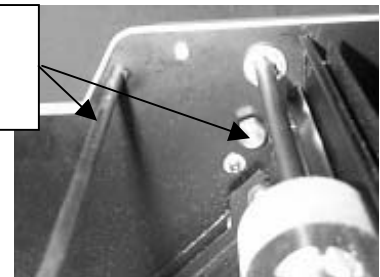

Figure #4

pins. Table should be mounted so that it clears the silver Philips head screws on the side frames (see **figure #6**). Lower the back of the feed table onto the support bar. **Note: Installing the feed table requires the red retarder press against the black feed wheel. This is normal and will not damage the unit. Do not attempt to adjust red retarder to assist feed table installation.**

Third-Verify feed table is seated properly onto support pins and support rod (see **figure #7**).

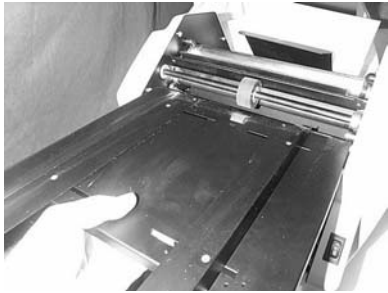

Figure #5
Starting feed table into folder

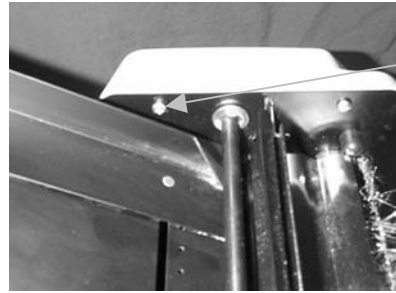
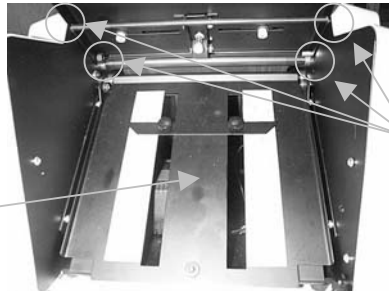

Figure #6
Close-up of feed table

Note that feed table slides in below Philips head screw



First Fold Table

Feed table installed on support pins and rod

Paper Guide Thumbscrews

Figure #7
View from under feed

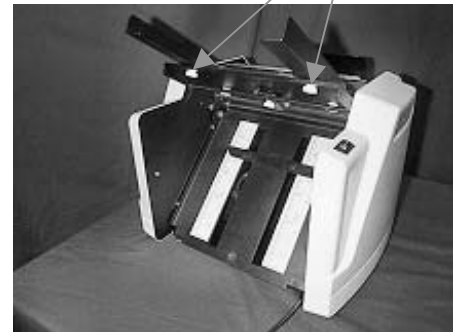

Figure #8

2.3 Paper Guides

Note: The folder is preset and tested for a standard 8½” X 11” letter fold.

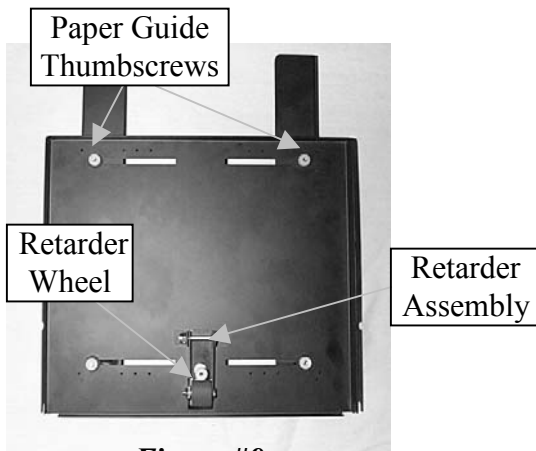
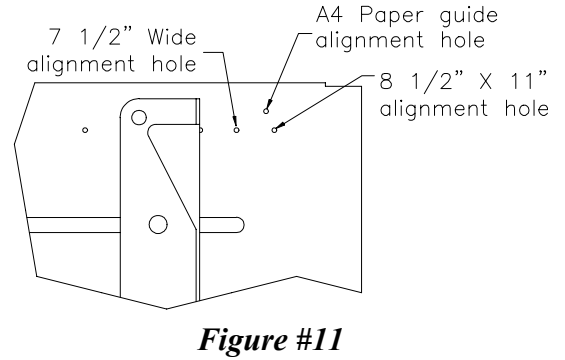
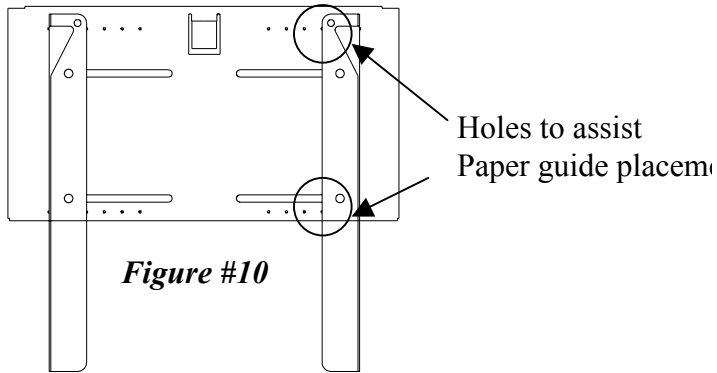

Figure #9
Bottom of Feed Table

To adjust the paper guides, loosen the four thumbscrews (see **figures #8 and #9**) under the feed table and slide them outward. Center a single sheet of paper under the feed wheel. Slide the paper guides in so they are 1mm away from the sides of the paper, and tighten the thumbscrews into place. The paper should be between the guides with a small amount of clearance to feed freely. If necessary, adjust the angle of the paper guides slightly for straight feeding. Small locating holes are in the feed table to assist in paper guide placement (see **figures #10 and #11**). For example, an 8½” wide sheet of paper results in the outermost holes intersecting with the edges of the paper guides. **NOTE: Align locating holes on the outside edges of the paper guides.** For odd widths of paper, these holes can be used as an aid in keeping the paper guides square with the folder.



Note: The folder is preset and tested for a standard 8 1/2 X 11 letter fold.

Before attempting to use this unit, one must understand the different types of folds (see figure #12 for examples of several common folds and their corresponding icons). A half fold requires that only the first fold table be set and used. All other folds require that both fold tables be set up and used.

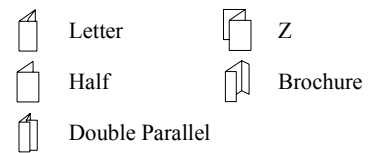

Figure #12

2.4.1 Double Fold operation

All folding operations apart from the half fold require two folds be placed in the stock. This is the case in the typical letter fold or typical Z-fold. The second fold table must be put into double fold position (see figure #13). If necessary, the second fold table may be moved by pulling out on the bottom edge and lowering or raising so that the double fold grommet is aligned with the mounting post (see figure #14). Fold table may then be pushed onto its mounting post. The paper stops on both fold tables must now be adjusted for the appropriate fold. Match icon color on both sets of labels to choose one of three common paper sizes (see figures #15 and #16). **NOTE: LTR=8 1/2 X 11" (Yellow), LGL=8 1/2 X 14" (Pink), A4=European (Blue).** Loosen the paper stop adjusting knobs and slide the paper stop to the desired set of icons, aligning the top edge of the paper stop with the arrows next to the desired icons. **NOTE: The user may find it easier to move the paper stops with the fold tables removed from the 1501.**

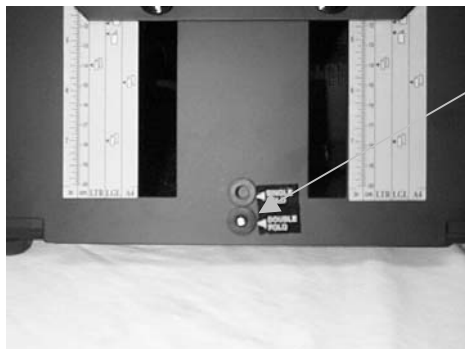
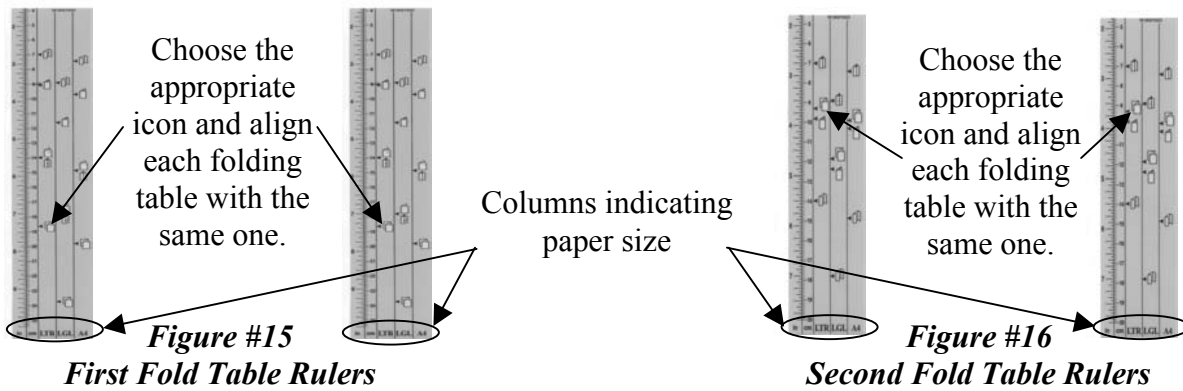

Figure #13
Fold table in double fold



Figure #14
Removing Fold Table

Fold Tables can be removed by pulling the bottom of the table off its mounting stud, and then gently pulling its upper slots from the folder. Installation is the reversal of the above.



2.4.2 Half Fold Operation

Half Fold Operation requires only one fold table be used (the first fold table in the 1501). First, the second fold table must be put into the single fold position (see figure #17). Do this by pulling out on the bottom edge of the fold table and lowering it so that the “single fold” hole is aligned with the mounting post. Fold table may then be pushed onto its mounting post. Once the second fold table is in the “single fold” position, this fold table is disabled and moving its paper stop will have no effect. The first fold table paper stop must now be adjusted for the half fold (see section 2.5 and figure #15 for paper stop placement). **Note: Use only the second exit tray as shown in figure #19.**

2.4.3 Custom Folds

To make custom folds, simply use the rulers to gauge the fold length measured from the paper stop edge to the fold. If the fold is longer on one side than the other, adjust the paper stop with a slight tilt to compensate.

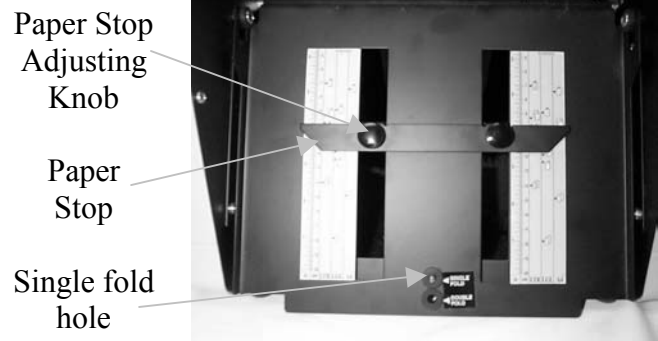

Figure #17
Second fold table in single fold position

2.5 Exit tray set-up

Place the first exit tray behind the folder with the long end up and the short lip pointed toward the folder (see figure #18).

The first exit tray should be centered and touching the folder. Place the second exit tray directly behind and on top of the first. The distance between the exit trays will vary with different types of folds. This distance can be adjusted until the desired paper stack is obtained. **Note: Use only the second exit tray when making half folds with the 1501 (see figure #19).**



Figure #18

First exit tray
Second exit tray, base goes on top of first exit tray
1501 set up for half folds, only second exit tray is used



Figure #19

3.0 Operation

3.1 Automatic Feed Operation

Make sure machine is powered Off. Set up the folder as described in section 2 of these instructions. Fan the stack of paper (see figure #20). Place the fanned paper onto the feed table (see figure #21) with the top sheet positioned where the feed roller and retarder meet. **Note: Top paper of stack goes into rollers first.** Place only a few sheets on the folder

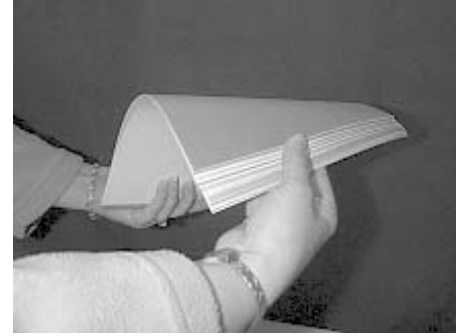

Figure #20

Person fanning paper to stagger stack

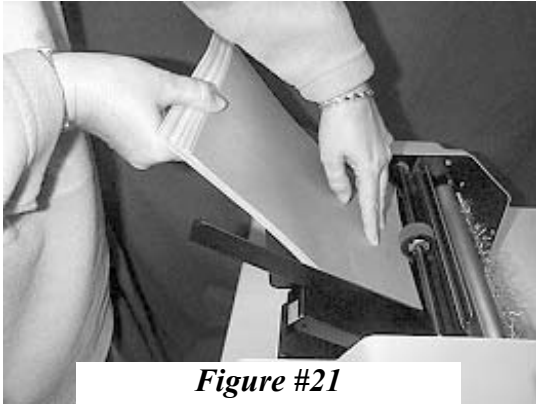

Figure #21

Fanned Paper in Feed Tray

and turn it on continuous run as denoted by 'I' on the OFF/ON switch. Inspect the folded

sheets for accuracy and stacking. Make any necessary corrections as described in sections 2.3 and 2.4. Run only a few sheets at a time until all necessary adjustments have been made. A full stack of paper may now be placed on the folder and run. For proper feeding, the stack must be squared in between the paper guides, and the paper should be fanned so that the top sheet is closest to the black feed wheel. Each sheet underneath is staggered backwards. **Note: When squaring the paper guides do not allow guides to pinch stock.**

3.2 Multiple Page Set Operation

Your unit is capable of folding up to three pieces of 105gsm bond stock at a time. This requires that the sets be fed one at a time through the top of the bonnet assembly. Set up the folder as described in Section 2.1, 2.3, and 2.5 of these instructions. Drop the paper in the slot located in the Upper Guide Assembly.

Hold the paper so that it rests squarely on the rollers located underneath (See figure #22). Initiate folding by depressing the 'I' portion of ON/OFF/MOMENTARY switch and hold down

Insert multiple page sets into this slot

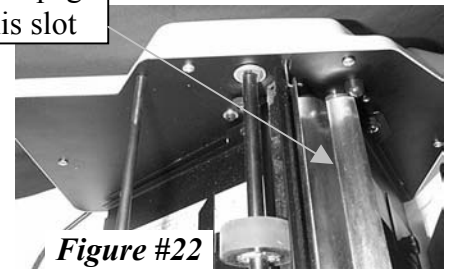

Figure #22

until the folding cycle is complete. The user may find that removing the feed table during long runs of multiple page set operation helps prevent unnecessary feed tire wear. **Note: Do not attempt to fold paper through the Upper Guide Assembly with the machine already running, or poor folds will result. To obtain straight folds, the front edge of the paper must be in the nip (pinch point) of the fold rollers before the machine starts running.**

4.0 Maintenance

4.1 Folding Rollers

During normal operation, the fold rollers will become coated with ink, toner, paper dust, and other contaminants. Contaminated fold rollers can cause a variety of folding problems including poor feeding and wrinkled paper. Periodic cleaning of the fold rollers will be necessary to maintain peak folding performance (approximately every 5,000-10,000 sheets). Use the following steps to clean folding rollers:

- Make sure that the power to the machine has been disconnected.
- Remove the Upper Guide Assembly by pushing it sideways into the right side frame until the left end is clear of the machine, and then lift the left end straight up and out (See figure #23).

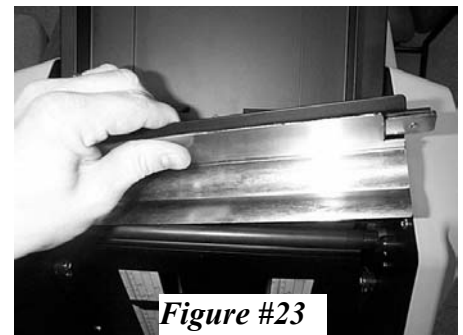

Figure #23

Liberally spray *Martin Yale Rubber Roller Cleaner and Rejuvenator* onto a clean, dry cloth. A mild soap solution on a damp cloth may also be used.

- Wipe down the exposed rollers until contaminants no longer appear on the cloth. Rotate the rollers by hand and continue cleaning until all the roller surfaces are clean (**See figure #24 for manual spinning of rollers**).
- If the surface of the rollers becomes glazed or shiny, it may be necessary to return them to a dull luster by using a lightly abrasive scouring pad such as 3M Scotchbrite®. **Do not use metal scouring pads such as steel wool, as damage to the rollers or bushings may result.**
- Re-install the Upper Guide Assembly in the reverse order as described in the first step.



Manually rotate rollers by spinning the center rubber roller, and one of the rollers next to it together.

Figure #24

4.2 Clearing Paper Jams

Use the following steps to clear a paper jam:

- Remove top guide assembly (**see figure #23**).
- Manually rotate rollers “turning” the jam out if possible (**see figure #24**).
- In the case of a severe jam, it may be necessary to remove each folding table by disengaging it off of its mounting pin and pulling it out of folder (**see figure #14**).

4.3 Feed Wheel

As with the fold rollers, contamination of the feed wheel may cause problems. When feeding becomes inconsistent, clean with *Martin Yale Rubber Roller Cleaner and Rejuvenator* and a soft cloth as described above.

4.4 Bushings

If the machine becomes sluggish, clean the fold rollers as outlined in 4.1 above and remove any contaminants from the ends of the shafts and bushings. Lubricate all bushings and shafts with one drop of common household machine oil (i.e. sewing machine oil) on the shaft where it enters the bushing (2 per shaft). **CAUTION: Do not allow oil to come in contact with the folding rollers. If oil is spilled on the folding rollers, remove immediately with *Martin Yale Rubber Roller Cleaner and Rejuvenator*.**

5.0 Troubleshooting

5.1 Machine will not run

5.1.1 Circuit Breaker has tripped

If the machine has jammed while folding, turn it off for about 10 minutes to allow thermal breaker to cool and reset. **WARNING! Motor will start automatically once it cools. Always turn machine off to allow cooling so as to avoid automatic starts.**

5.1.2 Dead receptacle

Try Folder in known good receptacle.

5.1.3 Electrical Malfunction

Have AutoFolder serviced by a qualified technician. Call Martin Yale customer service at (260)-563-0641 if further assistance is needed.

5.2 Paper will not feed

5.2.1 Paper guides are too tight

Adjust the paper guides so that a sheet slides freely between them. Review section 2.3.

5.2.2 Paper stack is not properly fanned

Review section 3.1 along with **figure #20** and **figure#21**.

5.2.3 Feed roller is contaminated

Clean the feed roller as outlined in section 4.3 of this manual.

5.2.4 Static electricity buildup

Fan or jog the paper to loosen the stack. *Martin Yale Static Eliminator Spray* may be used liberally spray over paper edges, feed tables, fold tables, and receiving tray.

5.2.5 Retarder roller has developed a flat wear area

Remove the feed table and lay upside down to gain access to the retarder bracket. Loosen nut on retarding locking screw and turn retarder to expose a new surface. **Note: Always turn retarder**

in the direction of the paper travel. Re-tighten the nut to lock the retarder in this position.

Note: The retarder roller should always be locked in a stationary position.

5.2.6 Paper has a curl in it

Paper will sometimes develop a curl that makes automatic feeding difficult. This is especially common in paper just printed from a laser jet printer. Stacking it and placing a large heavy object such as a large book on it for a couple hours can straighten paper. Another option is to place the paper on the 1501 feed table with the curl down.

5.2.7 Retarder pressure needs adjustment

Retarder pressure is pre-set at the factory and should require no further adjustment throughout the life of the folder. However, if feeding problems continue after following the above steps, the retarder pressure can be adjusted by turning the retarder pressure knob clockwise to increase pressure or counterclockwise to decrease pressure. The normal tendency is to place too much pressure on the retarder resulting in feed wheel damage. Call Martin Yale customer service at (260)-563-0641 if further assistance is needed.

5.3 Crooked Folds

5.3.1 Excessive paper guide side play

Readjust the paper guides to eliminate excessive side play between guides and paper edges, per section 2.3 of these instructions.

5.3.2 Paper guides not aligned properly

Align paper guides per section 2.3 of these instructions. Be sure paper stack is square and centered in the feed tray.

5.3.3 Paper stops not aligned properly

Align paper stops per section 2.4 of this manual. To rule out crooked feeding, test with single sheet of paper in single sheet operation, bypassing the feed tray completely.

5.4 Ink smudges on paper

5.4.1 Ink not dry

Allow additional ink drying time before folding. Some inks do not dry, they only set (dry to the touch). Because of the physical nature of friction feeding, you may notice a mark on the leading edge of the paper.

5.4.2 Excessive toner on photocopied stock

Check copy machine

5.5 Wrinkled paper

5.5.1 Feed table paper guides misaligned

Align the paper guides perpendicular to the folding rollers until the paper feeds straight into the folder. Review section 2.3.

5.5.2 Feed table paper guides too tight

Set guides so that sheets slide freely down between the guides without excessive side play. Review section 2.3.

5.5.3 Dirty Rollers

Dirty rollers are often the cause of wrinkled paper. Clean rollers as described in section 4.1.



MARTIN YALE
Industries

251 Wedcor Avenue

Wabash, Indiana 46992

Phone: (260) 563-0641 Fax (260) 563-4575

Email: info@martinyale.com Website: www.martinyale.com

MADE IN U.S.A.